

DC Inverter Air Source Heat Pumps (Monoblock Type)

1. Working source temperature range: -20°C to 45°C
2. Control Object: water tank temperature
(Setting range: Heating: $30^{\circ}\text{C} \sim 55^{\circ}\text{C}$; Cooling: $32^{\circ}\text{C} \sim 12^{\circ}\text{C}$)
3. Control Way: wire controller
4. Water Pump: start/stop according to water tank temp
5. Modes: hot water/house heating/house cooling

SPRSUN



CGK030V2



CGK050V2











CGK060V2



Guangzhou Sprsun New Energy Technology Development Co., Ltd.

Installation Diagram







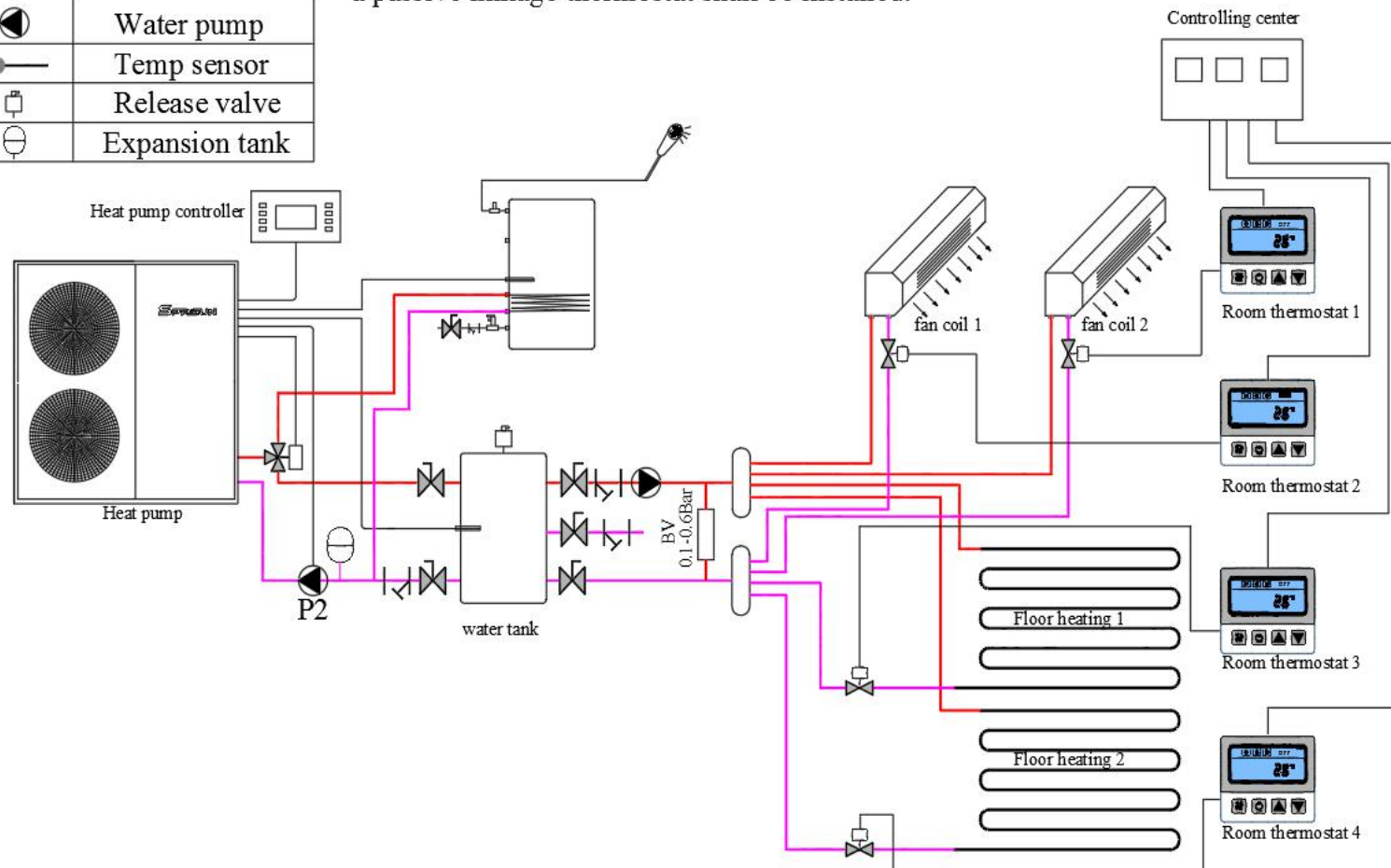

Symbol	Name
	3-way valve
	2-way valve
	Ball valve
	Non-return valve
	Filter
	Water pump
	Temp sensor
	Release valve
	Expansion tank

Notice:

1. Pls select the right modes according to your demand then install it according to the installation diagram. If only hot water function required, pls select heating+hot water mode , and then put the hot water sensor into the hot water tank.
2. Two-way valve and BV valve are optional for installation. Only If you need to control the temperature by different zone, then pls install both.
3. Fan coil can be controlled by linkage with the secondary circulation pump . Meanwhile, a passive linkage thermostat shall be installed.



SPRSUN DC inverter air source heat pump

Symbol	Name
	3-way valve
	2-way valve
	Ball valve
	Non-return valve
	Filter
	Water pump
	Temp sensor
	Release valve
	Expansion tank

Notice:

1. Pls select the right modes according to your demand then install it according to the installation diagram. If only hot water function required, pls select heating+hot water mode , and then put the hot water sensor into the hot water tank.





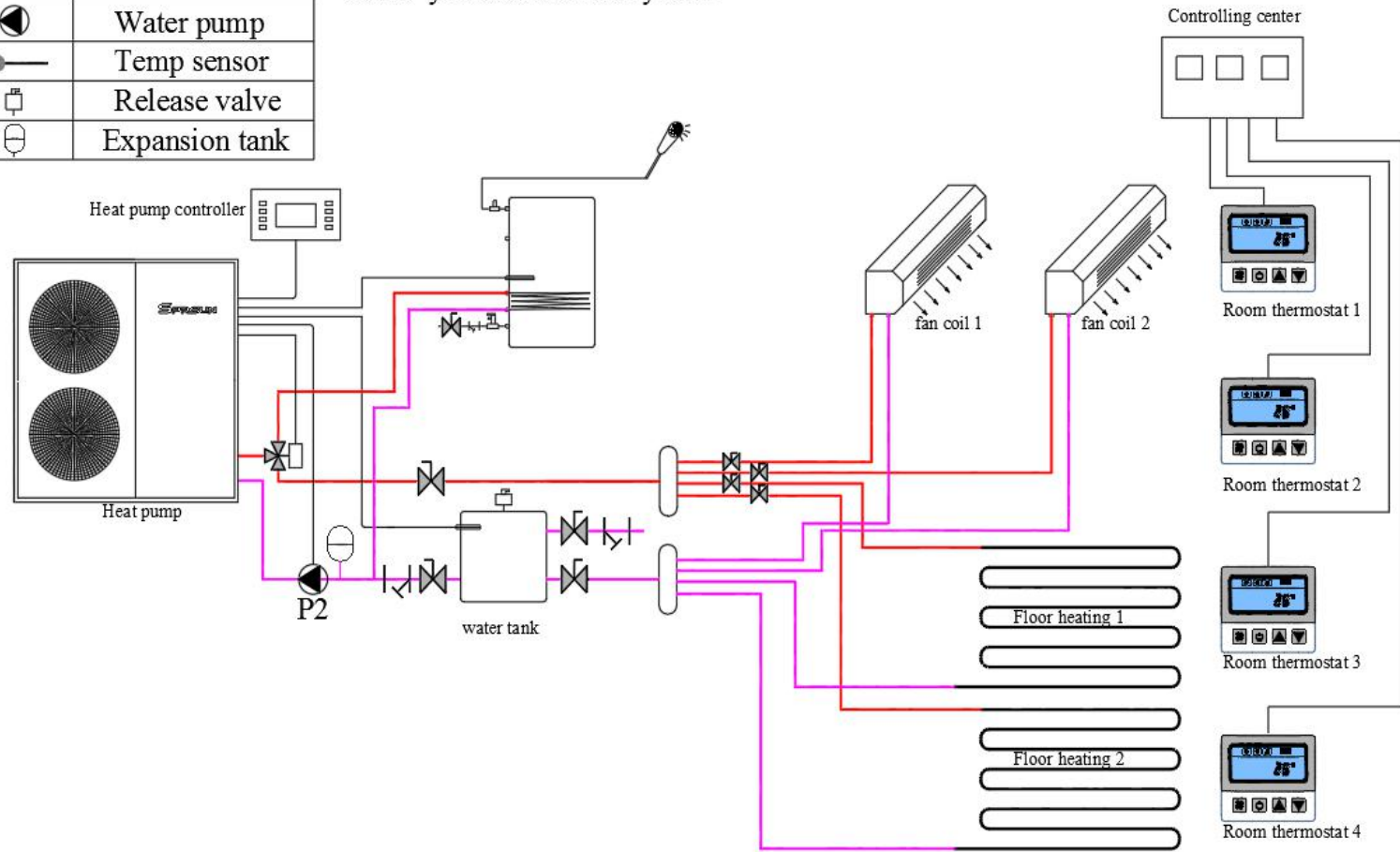



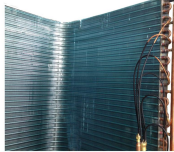

Fan coil can be controlled by linkage with the secondary circulation pump . Meanwhile, a passive linkage thermostat shall be installed.

3.This is rimary circulation system, If you not need to control the temperature by different zone, you can use this system.



SPRSUN DC inverter air source heat pump

Standard Materials

Name	Description	Picture	Name	Description	Picture	Name	Description	Picture
Condenser (copper)	Plate Heat Exchanger		Evaporator	Hydropilic Aluminium foil and internal thread copper pipe heat exchanger		High Pressure Sensor	0-4.5MPa	
Compressor	Panasonic Rotary Compressor		Expansion Valve	CAREL Electronic expansion valve		Low Pressure Sensor	0-3.45MPa	
4-way valve	SANHUA		AC Contactor and Thermal Relay	Eaton (Former brand is Moeller)		Package	corrugated board case / plywood case	
Controller	CAREL Controller		DC Fan	WOLONG DC Fan				

Functions

1. How to Start Electric Heater?

There are two kinds of electric heaters: backup electric heater and crank heater. The corresponding electric heater can be enabled in M04 menu.

In heating mode (without defrosting), start backup electric heater when all the following conditions are met:

- (1) Enable the backup electric heater function;
- (2) Ambient temperature \leq the ambient temperature when starting electric heater (default value 0°C);
- (3) Target temperature \leq heating temperature set point - deviation value under electric heating (default value 5°C);
- (4) It takes more than 5min to start the compressor (adjustable);

In heating mode (without defrosting), turn off backup electric heater if any of the following conditions is met:

- (1) Ambient temperature \geq the ambient temperature when starting electric heater + 3°C;
- (2) Target temperature \geq heating temperature set point;
- (3) Ambient temperature sensor error;
- (4) Power off.

2. How to Enter Defrosting?

When the air-cooled unit is in the heating mode, the outdoor coil works as evaporator. If the outdoor temperature is too low, frost may form on the coil, which means that the working efficiency of the unit will be reduced. In this case, the heating mode should be temporarily switched to the cooling mode for defrosting, and then return to the heating mode, so that the unit can resume its high efficiency.

Defrosting Conditions:

Defrosting will be enabled when the following conditions are met at the same time:

- (1) Time between two defrosting cycles \geq defrosting interval, unit: min, default value: 45;
- (2) Ambient temperature \leq defrosting ambient temperature, lasting for 2s, default value is 20°C (this condition is ignored when there is ambient temperature sensor error);
- (3) Ambient temperature - evaporation temperature \geq defrosting temperature difference, lasting for 2min, the default value is 5°C; this condition is ignored when there is ambient temperature sensor error;
- (4) Evaporation temperature \leq defrosting set point, lasting for 2s, default value -1°C;

Defrosting set point: according to the compensation of ambient temperature, the lower the ambient temperature is, the lower the setting point will be.

Implementing the manual forced defrosting command will ignore the above entry conditions.

Defrosting will quit if any of the following conditions is met:

- (1) Defrosting time \geq maximum defrosting time, the default value is 8min;
- (2) Condensation/coil temperature \geq the setting point of exiting defrosting, default value 15°C;
- (3) Power off.

Unit Name **DC Inverter Air Source Heat Pumps (Monoblock Type)**



Model		CGK030V2	CGK040V2	CGK050V2	CGK060V2	CGK-030V2	CGK-040V2	CGK-050V2	CGK-060V2
Power Supply / Refrigerant	V/Hz/Ph	220-240/50/1 - R410A	220-240/50/1 - R410A	220-240/50/1 - R410A	220-240/50/1 - R410A	380-420/50/3 - R410A	380-420/50/3 - R410A	380-420/50/3 - R410A	380-420/50/3 - R410A
Max. Heating Capacity (1)	kW	9.5	12.5	16.5	18.5	9.6	12.5	16.6	18.6
C.O.P (1)	W/W	4.45	4.45	4.48	4.39	4.45	4.52	4.52	4.42
Heating Capacity Min./Max.(1)	kW	4.37 / 9.5	5.75 / 12.5	7.59 / 16.5	8.51 / 18.5	4.416 / 9.6	5.75 / 12.5	7.636 / 16.6	8.556 / 18.6
Heating Power Input Min./Max.(1)	W	786 / 2135	1034 / 2809	1355 / 3683	1551 / 4214	794 / 2157	1018 / 2765	1352 / 3673	1549 / 4208
C.O.P Min./Max.(1)	W/W	4.45 / 5.56	4.45 / 5.56	4.48 / 5.60	4.39 / 5.49	4.45 / 5.56	4.52 / 5.65	4.52 / 5.65	4.42 / 5.53
Max. Heating Capacity(2)	kW	8.9	11.8	15.5	17.4	9.0	11.8	15.6	17.5
C.O.P (2)	W/W	3.60	3.60	3.58	3.40	3.60	3.62	3.62	3.43
Heating Capacity Min./Max.(2)	kW	4.11 / 8.93	5.41 / 11.75	7.13 / 15.51	8.00 / 17.39	4.15 / 9.02	5.41 / 11.75	7.18 / 15.60	8.04 / 17.48
Heating power input Min./Max.(2)	W	972 / 2508	1279 / 3301	1676 / 4328	1918 / 4952	982 / 2535	1259 / 3249	1672 / 4315	1915 / 4945
C.O.P Min./Max.(2)	W/W	3.56 / 4.23	3.56 / 4.23	3.58 / 4.26	3.51 / 4.17	3.56 / 4.23	3.62 / 4.29	3.62 / 4.29	3.54 / 4.20
Max. Cooling Capacity(3)	kW	8.5	11.2	14.7	16.5	8.6	11.2	14.8	16.6
E.E.R (3)	W/W	3.50	3.50	3.48	3.30	3.50	3.51	3.51	3.32
Cooling Capacity Min./Max.(3)	kW	3.90 / 8.48	5.13 / 11.16	6.78 / 14.73	7.60 / 16.52	3.94 / 8.57	5.13 / 11.16	6.82 / 14.82	7.64 / 16.61
Cooling Power Input Min./Max.(3)	W	942 / 2871	1239 / 3778	1625 / 4953	1859 / 5667	952 / 2901	1220 / 3719	1620 / 4939	1857 / 5659
E.E.R Min./Max.(3)	W/W	2.95 / 4.14	2.95 / 4.14	2.97 / 4.17	2.91 / 4.09	2.95 / 4.14	3.00 / 4.21	3.00 / 4.21	2.93 / 4.12
Max. Cooling Capacity(4)	kW	6.7	8.8	11.6	13.0	6.8	8.8	11.7	13.1
E.E.R(4)	W/W	2.62	2.62	2.61	2.48	2.62	2.63	2.63	2.49
Cooling Capacity Min./Max.(4)	kW	3.08 / 6.70	4.05 / 8.81	5.35 / 11.63	6.00 / 13.04	3.11 / 6.77	4.05 / 8.81	5.38 / 11.70	6.03 / 13.11
Cooling Power Input Min./Max.(4)	W	845 / 2667	1112 / 3509	1458 / 4601	1668 / 5264	854 / 2695	1095 / 3454	1454 / 4587	1666 / 5256
E.E.R Min./Max.(4)	W/W	2.51 / 3.65	2.51 / 3.65	2.53 / 3.67	2.48 / 3.60	2.51 / 3.65	2.55 / 3.70	2.55 / 3.70	2.49 / 3.62
Max. Heating Capacity (5)	kW	7.2	9.5	12.5	14.1	7.3	9.5	12.6	14.1
C.O.P(5)	W/W	3.44	3.44	3.46	3.39	3.44	3.49	3.49	3.42
Heating Capacity Min./Max.(5)	kW	3.32 / 7.22	4.37 / 9.50	5.77 / 12.54	6.47 / 14.06	3.36 / 7.30	4.37 / 9.50	5.80 / 12.62	6.50 / 14.14
Heating Power Input Min./Max.(5)	W	772 / 2099	1016 / 2762	1333 / 3621	1525 / 4143	781 / 2121	1001 / 2719	1329 / 3611	1523 / 4137
C.O.P Min./Max.(5)	W/W	3.44 / 4.30	3.44 / 4.30	3.46 / 4.33	3.39 / 4.24	3.44 / 4.30	3.49 / 4.37	3.49 / 4.37	3.42 / 4.27
Max. Heating Capacity (6)	kW	7.0	9.2	12.2	13.7	7.1	9.2	12.2	13.7
C.O.P(6)	W/W	2.92	2.92	2.90	2.75	2.92	2.93	2.93	2.77
Heating Capacity Min./Max.(6)	kW	3.22 / 7.01	4.24 / 9.22	5.60 / 12.17	6.28 / 13.65	3.26 / 7.08	4.24 / 9.22	5.63 / 12.25	6.31 / 13.72
Heating Power Input Min./Max.(6)	W	884 / 2402	1163 / 3161	1544 / 4196	1824 / 4956	893 / 2427	1159 / 3151	1540 / 4184	1821 / 4949
C.O.P Min./Max.(6)	W/W	2.92 / 3.65	2.92 / 3.65	2.90 / 3.63	2.75 / 3.44	2.92 / 3.65	2.93 / 3.66	2.93 / 3.66	2.77 / 3.47
Rated Current	A	10.2	13.4	17.6	20.2	4.6	5.8	7.8	8.9
Max Current	A	14.81	19.49	25.55	29.24	6.60	8.46	11.24	12.88
Compressor	Type - Quantity/System	Twin Rotary - 1		Twin Rotary - 1		Twin Rotary - 1		Twin Rotary - 1	
Fan	Quantity	1		1		2		2	
	Airflow	3000		3500		5000		5500	
	Rated power	100		110		200		210	
Water Side Heat Exchanger	Type	Plate Heat Exchanger		Plate Heat Exchanger		Plate Heat Exchanger		Plate Heat Exchanger	
	Water Pressure Drop	20		22		23		25	
	Piping Connection	Inch G1"		Inch G1"		Inch G1"		Inch G1"	
Allowable Water Flow	Min./Rated./Max.	0.28 0.45 0.76	0.37 0.60 1.00	0.49 0.79 1.31	0.55 0.88 1.47	0.29 0.46 0.76	0.37 0.60 1.00	0.50 0.79 1.32	0.56 0.89 1.48
Noise Level	dB(A)	59		59		62		63	
Net Dimension(L×D×H)	mm	1110*475*810		1110*475*910		1110*475*1355		1110*475*1355	
Packing Dimension(L×D×H)	mm	1220*540*970		1220*540*1070		1220*540*1400		1220*540*1400	
Net Weight	Kg	88		98		124		124	
Gross Weight	Kg	116		126		161		161	

Note: (1) Heating condition: water inlet/outlet temperature: 30°C/35°C, Ambient temperature: DB 7°C/WB 6°C;

(2) Heating condition: water inlet/outlet temperature: 40°C/45°C, Ambient temperature: DB 7°C/WB 6°C;

(3) Cooling condition: water inlet/outlet temperature: 23°C/18°C, Ambient temperature: DB35°C/WB24°C;

(4) Cooling condition: water inlet/outlet temperature: 12°C/7°C, Ambient temperature: DB35°C/WB24°C;

(5) Heating condition: water inlet/outlet temperature: 30°C/35°C, Ambient temperature: DB -7°C/WB -8°C;

(6) Heating condition: water inlet/outlet temperature: 40°C/45°C, Ambient temperature: DB -7°C/WB -8°C;

Heating Capacity at Different Conditions

Model	CGK030V2			CGK040V2			CGK050V2			CGK060V2			CGK-030V2			CGK-040V2			CGK-050V2			CGK-060V2		
Air temp °C	Heating capacity (KW)			Heating capacity (KW)			Heating capacity (KW)			Heating capacity (KW)			Heating capacity (KW)			Heating capacity (KW)			Heating capacity (KW)			Heating capacity (KW)		
-20	4.39	3.72	1.12	5.77	4.89	1.47	7.62	6.46	1.94	8.54	7.24	2.17	4.43	3.76	1.13	5.77	4.89	1.47	7.67	6.50	1.95	8.59	7.28	2.18
-15	5.85	4.96	2.97	7.70	6.52	3.91	10.16	8.61	5.17	11.39	9.66	5.79	5.91	5.01	3.01	7.70	6.52	3.91	10.22	8.66	5.20	11.45	9.71	5.82
-7	7.19	6.98	6.35	9.46	9.19	8.36	12.49	12.13	11.04	14.01	13.60	12.38	7.27	7.06	6.42	9.46	9.19	8.36	12.57	12.20	11.10	14.08	13.67	12.44
2	8.46	8.22	7.97	11.13	10.81	10.49	14.70	14.27	13.84	16.48	16.00	15.52	8.55	8.30	8.05	11.13	10.81	10.49	14.79	14.36	13.93	16.57	16.09	15.60
7	9.50	8.93	8.48	12.50	11.75	11.16	16.50	15.51	14.73	18.50	17.39	16.52	9.60	9.02	8.57	12.50	11.75	11.16	16.60	15.60	14.82	18.60	17.48	16.61
12	9.98	9.38	8.91	13.13	12.34	11.72	17.33	16.29	15.47	19.43	18.26	17.35	10.08	9.48	9.00	13.13	12.34	11.72	17.43	16.38	15.56	19.53	18.36	17.44
20	10.47	9.85	9.35	13.78	12.95	12.31	18.19	17.10	16.24	20.40	19.17	18.21	10.58	9.95	9.45	13.78	12.95	12.31	18.30	17.20	16.34	20.51	19.28	18.31
Hot water temp °C	30/35	40/45	50/55	30/35	40/45	50/55	30/35	40/45	50/55	30/35	40/45	50/55	30/35	40/45	50/55	30/35	40/45	50/55	30/35	40/45	50/55	30/35	40/45	50/55

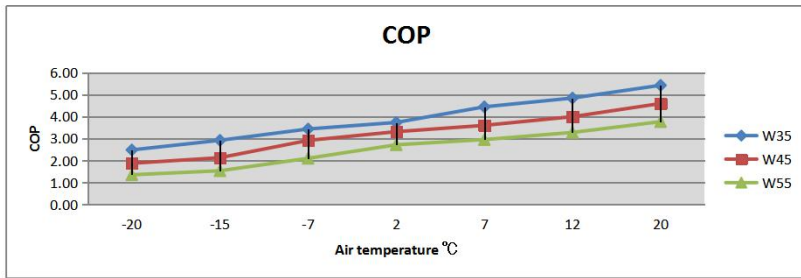

Air temp °C	COP kW/kW		
-20	2.48	1.87	1.35
-15	2.92	2.13	1.53
-7	3.44	2.92	2.10
2	3.74	3.32	2.72
7	4.45	3.60	2.96
12	4.85	4.00	3.28
20	5.43	4.60	3.77
Hot water temp °C	35	45	55